

Data Sheet



Article number: 204280M16150D3U

Description: E+G levelling foot
GN 42-80-M16-150-D3-U

Note: U Without nut, Hexagon socket at the top, Wrench flat at the bottom

Measures

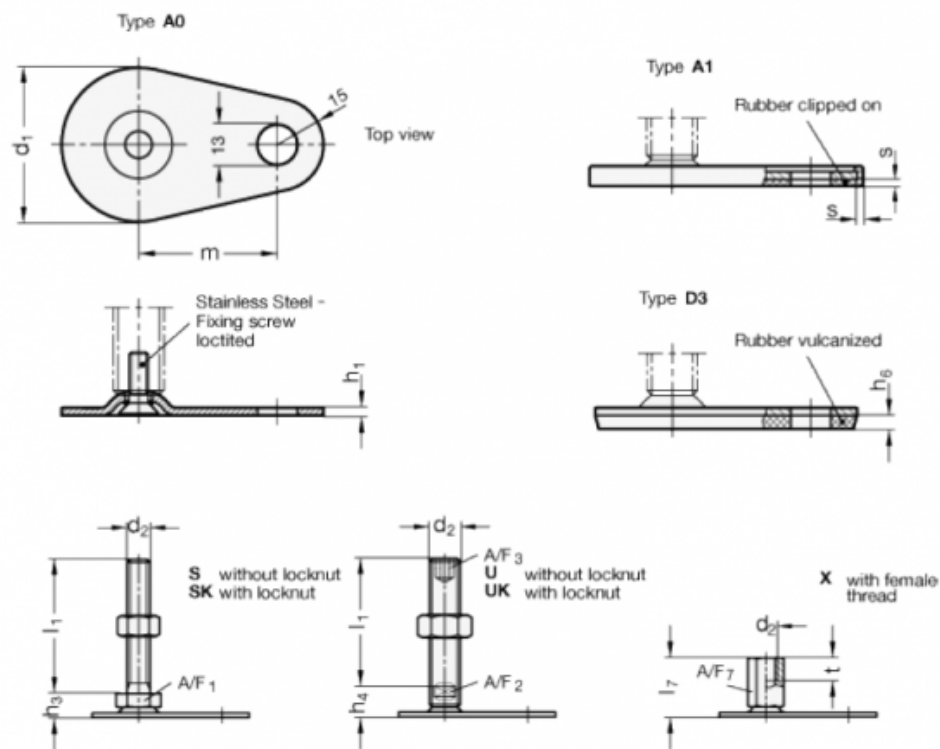

A/F2 = 12	m = 70
A/F3 = 8	s =
d1 = 80	
d2 = M16	
h1 = 3	
h4 = 18	
h6 = 5	
l1 = 150	